

# Fiber's Role in Smart Buildings – Considerations for Deployment and Testing

Rodney Casteel, RCDD, DCDC, NTS, OSP – CommScope – Chair TIA FOTC

Jim Davis – Fluke Networks – Membership Chair TIA FOTC

Tyler Vander Ploeg, RCDD – VIAVI Solutions

Rob Gilberti – AFL

Romain Tursi – EXFO

COMMSCOPE®

VIAVI

EXFO

AFL

FLUKE  
networks

**TIA FOTC**  
TIA's Fiber Optics Tech Consortium  
[www.tiafotc.org](http://www.tiafotc.org)

2019 **BICSI FALL**  
Conference & Exhibition

**Bicsi**

# Agenda

## First Half – 80 minutes

- FOTC Introduction – Rodney Casteel
- Fiber and Smart Buildings – Rodney Casteel
  - Standards & Trends
  - Architectures
- Panel - Fiber Testing & Inspection – Test Manufacturers

## Break – 15 minutes

## Second Half – 80 minutes

- Hands-on stations



# Fiber Optics Tech Consortium

## [www.tiafotc.org](http://www.tiafotc.org)

- Part of the Telecommunications Industry Association ([www.tiaonline.org](http://www.tiaonline.org))
- Formed 25 years ago as the Fiber Optics LAN Section.
- Mission: to provide current, reliable, and vendor neutral information about fiber optics and related technologies for advancing new and better communications solutions.
- Webinars posted on website [www.tiafotc.org](http://www.tiafotc.org) or FOTC channel on Bright Talk
  - Webinars are eligible for CEC credit for up to two years after they are first broadcast. Email [liz@goldsmithpr.com](mailto:liz@goldsmithpr.com) to receive your CEC.



[www.tiafotc.org](http://www.tiafotc.org)

2019 **BICSI FALL**  
Conference & Exhibition



# Fiber Optics Technology Consortium

## Current Members

- AFL
- CommScope
- DASAN Zhone Solutions
- EXFO
- Fluke Networks
- General Cable
- Legrand

## Current Members

- OFS
- Rosenberger North America
- Sumitomo Electric Lightwave
- Superior Essex
- The Siemon Company
- Viavi

# Fiber Optics Technology Consortium

- Recent Webinars Available on Demand
  - Testing the Network's Fiber Foundation to support 5G, IoT and more
  - Field Testing and Troubleshooting of PON LAN Networks
  - LAN Standards, News & Trends: 2019 Update
- Visit [www.tiafotc.org](http://www.tiafotc.org) or our channel on BrightTalk
  - TIA's BrightTalk Channel: [www.brighttalk.com/channel/727](http://www.brighttalk.com/channel/727)
- Webinars are eligible for CEC credit for up to two years after they are first broadcast. Email [liz@goldsmithpr.com](mailto:liz@goldsmithpr.com) if you have completed a webinar and want to receive your CEC.

# Important Notice

Any product(s) identified or identifiable via a trade name or otherwise in this presentation as a product(s) supplied by a particular supplier(s) is provided for the convenience of users of this presentation and does not constitute an endorsement of any kind by TIA of the product(s) named. This information may be provided as an example of suitable product(s) available commercially. Equivalent product(s) may be used if they can be shown to lead to the same results.

# Optical Fiber Standard's Update

Rodney Casteel RCDD/NTS/OSP/DCDC - CommScope

*Thanks to FOTC Standards Chair Cindy Montstream, Legrand, North America & Co-Chair Paul Neveux, Jr., Ph.D., Superior Essex for providing standards content*



# IEEE 802.3

Working group that develops standards for  
Ethernet based LANs  
([WWW. IEEE802.org](http://WWW.IEEE802.org))



# EXISTING OPTICAL FIBER Standards



# Review: 10/40/100/400 Gb Ethernet on MMF

Ethernet Speed	IEEE Task Force	Designation	Fiber Type	Number of Fibers	Maximum Link Length (m)	Maximum Channel Insertion Loss (dB)
10 Gb	802.3ae	10GBASE-SR	OM3	2	300	2.6
40 Gb	802.3ba	40GBASE-SR4	OM3	8	100	1.9
40 Gb	802.3ba	40GBASE-SR4	OM4	8	150	1.5
100 Gb	802.3ba	100GBASE-SR10	OM3	20	100	1.9
100 Gb	802.3ba	100GBASE-SR10	OM4	20	150	1.5
100 Gb	802.3bm	100GBASE-SR4	OM4	8	100	1.9
400 Gb	802.3bs	400GBASE-SR16	OM3/4/5	32	80/100/100	1.9

# Review: 40/100/200/400 Gb Ethernet on SMF

Ethernet Speed	IEEE Standard	Designation	Lanes	Total Number of Fibers	Max. Link Length	Max. Channel Insertion Loss (dB)	Reflectance 2 Connectors (< -55 dB)	Reflectance 10 Connectors (< -55 dB)
40 Gb/s	802.3ba	40GBASE-IR4 40GBASE-LR4	4 (4 $\lambda$ )	2	2 km 10 km	4.5 6.7	-26 dB	
100 Gb/s	802.3ba	100GBASE-LR4	4 (4 $\lambda$ )	2	10 km	6.3	-26 dB	
200 Gb/s	802.3bs	200GBASE-DR4	4	8	500 m	3.0	-42 dB	-49 dB
		200GBASE-FR4	4 (4 $\lambda$ )	2	2 km	4.0	-31 dB	-40 dB
		200GBASE-LR4	4 (4 $\lambda$ )	2	10 km	6.3	-29 dB	-38 dB
400 Gb/s	802.3bs	400GBASE-DR4	4	8	500 m	3.0	-42 dB	-49 dB
		400GBASE-FR8	8 (8 $\lambda$ )	2	2 km	4.0	-31 dB	-40 dB
		400GBASE-LR8	8 (8 $\lambda$ )	2	10 km	6.3	-29 dB	-38 dB

# Technology Roadmap

The pace of change in connectivity bandwidth and footprint is accelerating greatly...

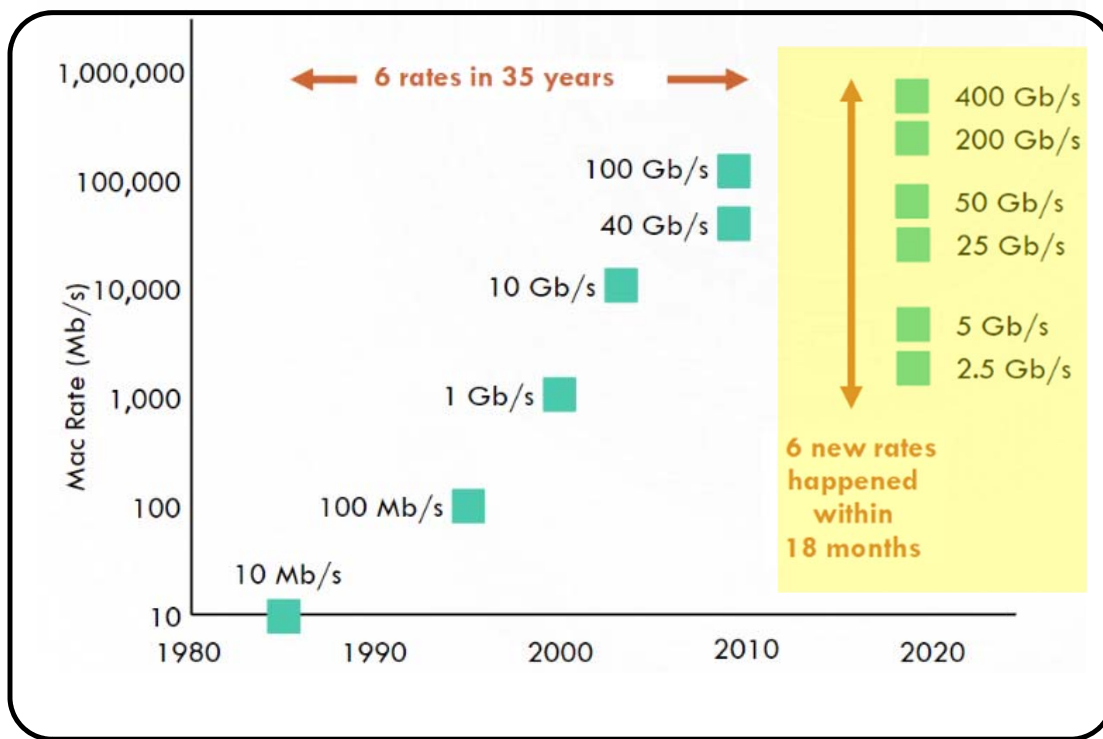

Source: Senko, 2018

## Technology Trends:

- Increased share of pre-term MPO (parallel optics) and plug-and-play solutions vs field terminated on-site
- Rapid advancement in bandwidth options
- Growth of WDM-based links increasing channel bandwidth from 10G to 25G to 50G
- Increased demand in single mode fiber (SMF) and ultra low loss links
  - ✓ SMF offer longer transmission distance
  - ✓ SMF lasts multiple generations
  - ✓ SMF optics becoming price competitive with MMF
- Emergence of OM5/WBMMF (20-30% price premium)

# IEEE 802.3cd 50/100/200 Gb/s Ethernet

- 50 Gb/s Ethernet PHYs
  - MMF with lengths up to at least 100 m (OM4/5; 50GBASE-SR)
  - SMF with lengths up to at least 2 km and lengths up to at least 10 km
- 100 Gb/s Ethernet PHYs
  - MMF with lengths up to at least 100 m (OM4/5; 100GBASE-SR2)
  - Duplex SMF with lengths up to at least 500 m
- 200 Gb/s Ethernet PHYs
  - MMF with lengths up to at least 100 m (OM4/5; 200GBASE-SR4)

# 802.3cm 400 Gb/s over MMF Objectives

- Support a MAC data rate of 400 Gb/s
- Define a physical layer specification that supports 400 Gb/s operation over 8 pairs of MMF with lengths up to at least 100m
- Define a physical layer specification that supports 400 Gb/s operation over 4 pairs of MMF with lengths up to at least 100m
- Two implementations
  - 400GBASE-SR8 using a 16 or 24 fiber MPO (8 fibers)
  - 400GBASE-SR4.2 over two wavelengths using 12 fiber MPO (4 fibers/2 wavelengths)
    - SR4.2 Wavelengths resolved: Nominal 850 nm and 910 nm

# 400GBASE-SR4.2 Link Power Budget

Parameter	OM3	OM4	OM5	Unit
Effective modal bandwidth at 850 nm <sup>a</sup>	2000	4700	4700	MHz-km
Effective modal bandwidth at 918 nm	1210	1850	2890	MHz-km
Power budget (for max TDECQ)	6.6			dB
Operating distance	70	100	150	m
Channel insertion loss <sup>c</sup>	1.8	1.9	2	dB
Allocation for penalties <sup>d</sup> (for max TDECQ)	4.6			dB
Additional insertion loss allowed	0.2	0.1	0	dB

# Smart Buildings

Rodney Casteel RCDD/NTS/OSP/DCDC - CommScope

COMMScope®



# Technology Trends



Fiber



Copper



In-building wireless



Wireless



PoE & Convergence

Quality of Life



5G & Mobility



Edge Data Centers



Concealment Solutions

## SUSTAINABLE DEVELOPMENT GOALS





Worlds largest transportation company owns no vehicles

Worlds largest lodging company owns no properties

World's most valuable retailer, has no inventory



Track



Monitor



Control

# 5G – A Network of Networks



1 Enhanced mobile broadband



2 Internet of things



3 Ultra-low latency

UP TO **10** GBPS PER SUBSCRIBER

**1-7** TYPICAL GBPS PER SUBSCRIBER

**10-100x** CONNECTED DEVICES

MORE THAN **20** BILLION THINGS

**1,000x** MORE BANDWIDTH

**5x** LOCATION DENSITY

LESS THAN **5** MILLISECONDS

**5%** OF 4G

# Smart City Connectivity

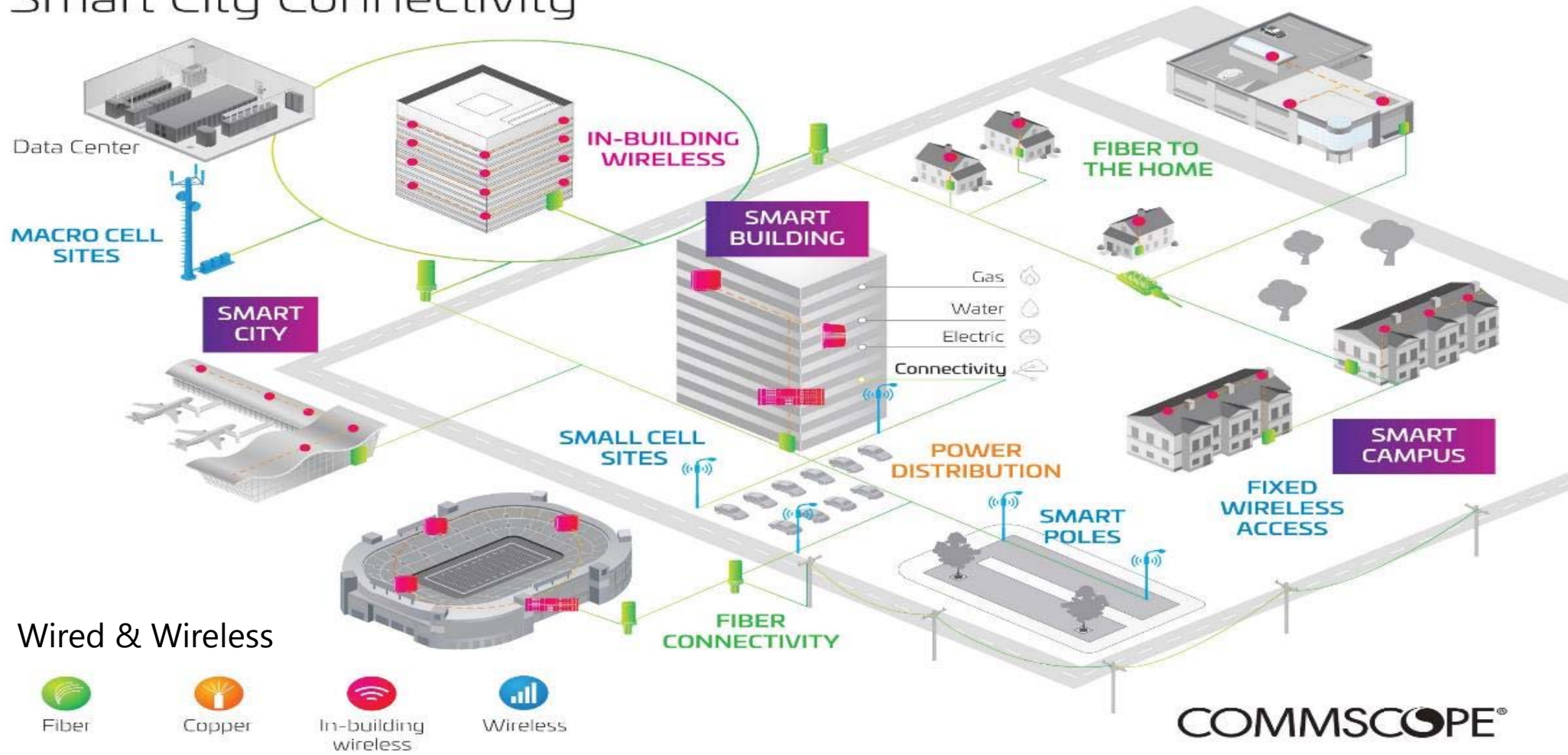

Connectivity is the key to efficiency and enriching lives  
What is the number one rule

for Real Estate?

Connectivity, Connectivity,  
Connectivity



# Smart Buildings & Connectivity



# Enterprise Network - Hierarchical Star

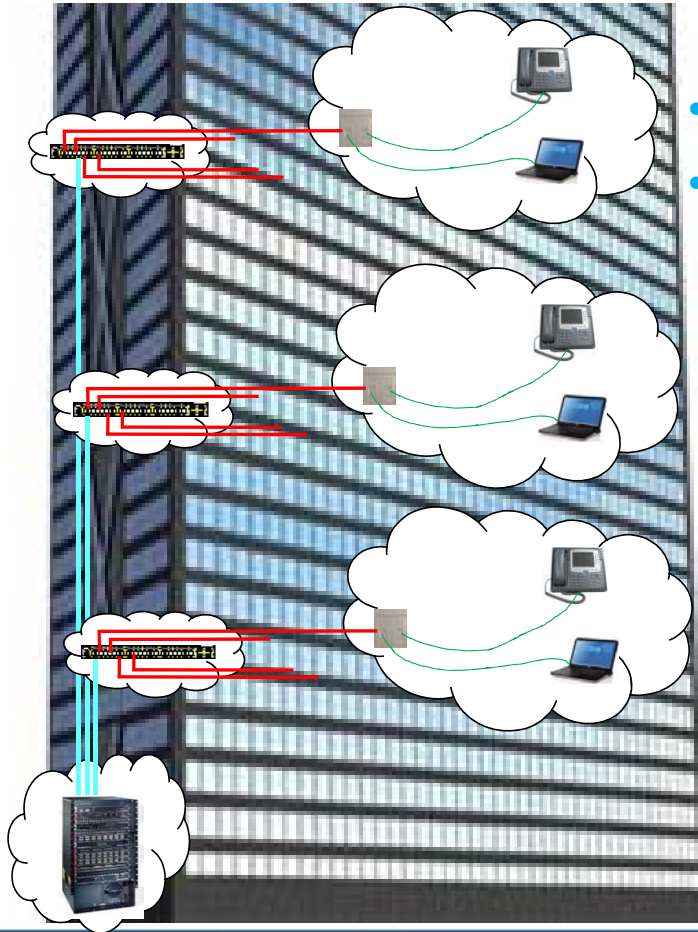

- Core/Distribution switches in basement
- Access switches typically on each floor
  - Uplinks are MMF or SMF
  - Horizontal links to desktop are UTP
  - Devices are patched at faceplate or direct connect in the ceiling

# Enterprise Network – PON Passive Optical LANs (POL)

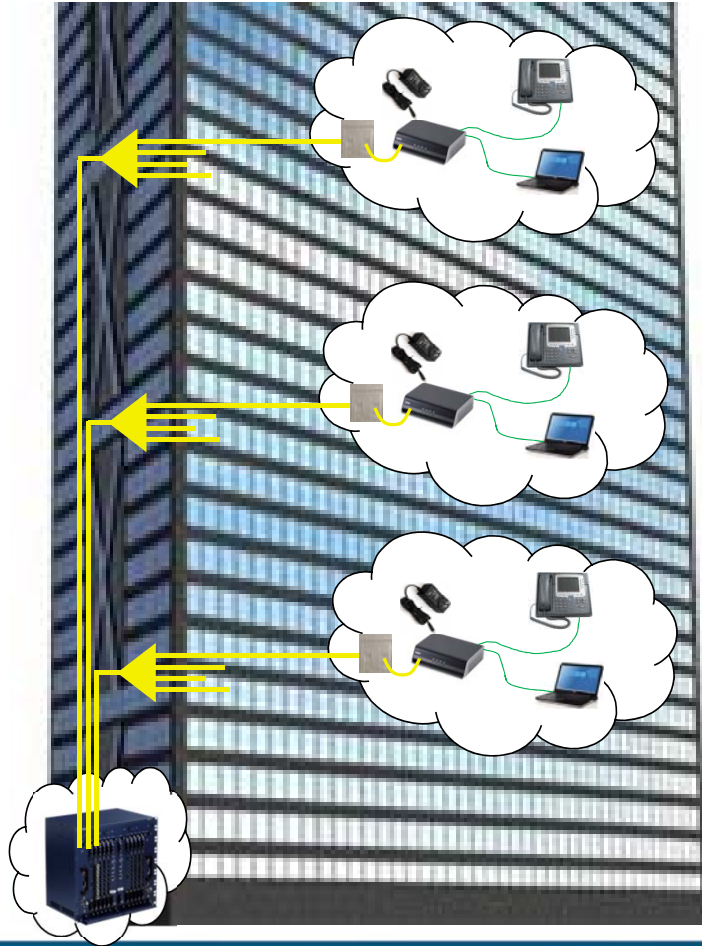

- OLT and core switch in MDF
- Splitters may be located in MDF, per floor or cascaded
  - SMF to desktop faceplate
  - ONU at desktop, requires power
  - Devices are patched to ONU



# Inbuilding Wireless

- WiFi
- Small Cell
- DAS
- CBRE

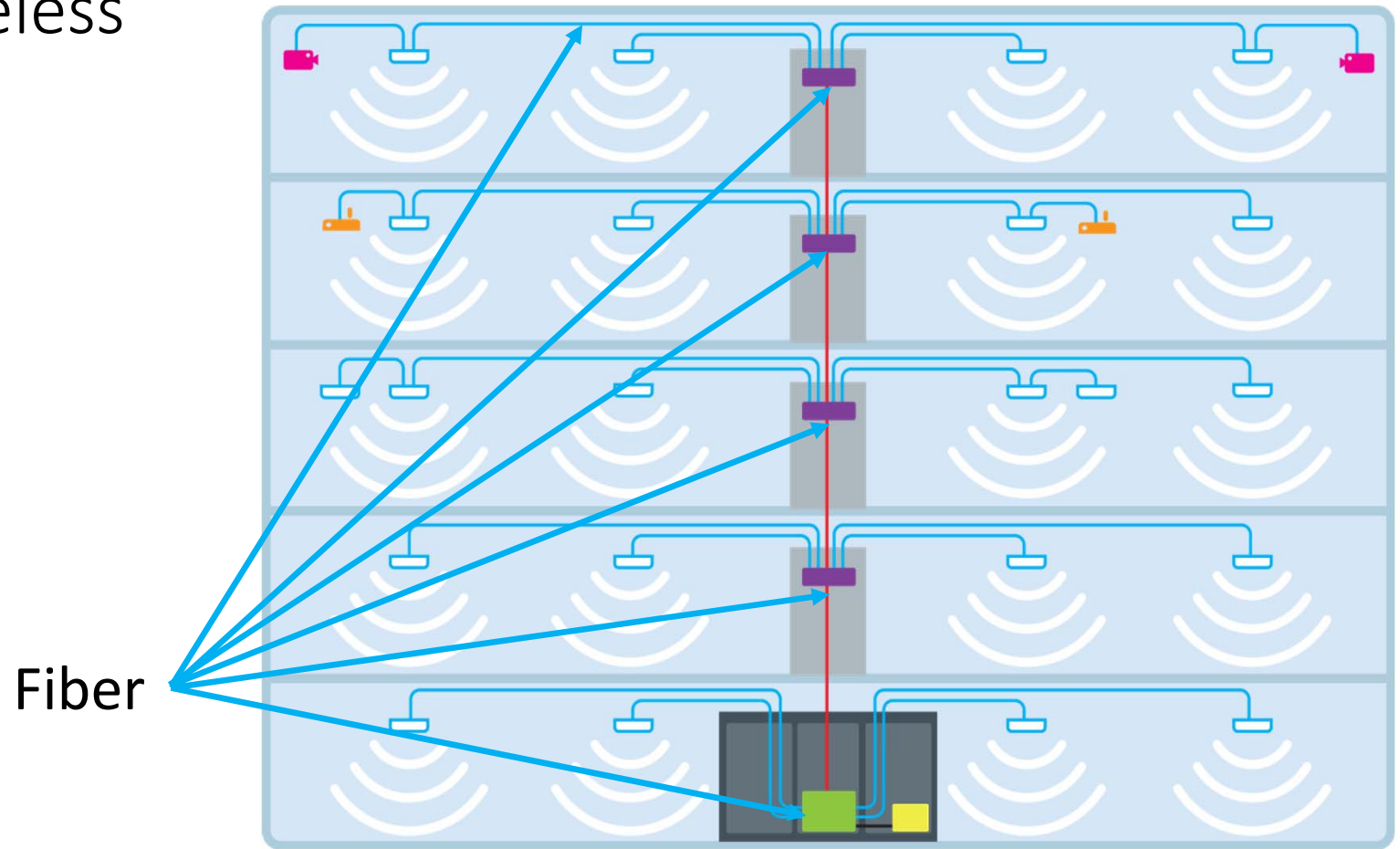

A FULLY CONNECTED YOU!!

A FULLY CONNECTED WORLD!!



# Fiber Inspection and Cleaning

Jim Davis  
Regional Marketing Engineer  
Fluke Networks

# *Inspect, Clean, Repeat as needed*



**Video Microscope**

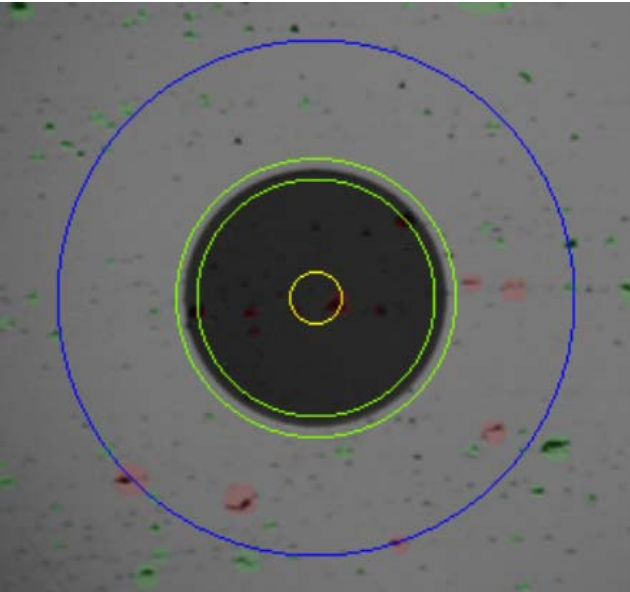

**Brand new out of bag**

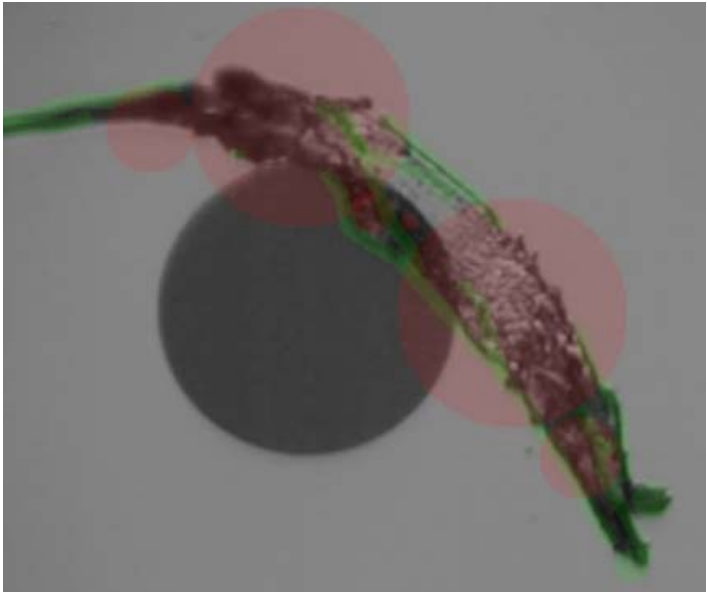

**After Cleaning** 😬

# How to Clean Fiber End-faces

- My Travel Kit
  - I take a lot of international trips where I cross borders – no instruments
- I start with Dry – “click” connectors
  - 1.25mm, 2.5mm
- If that doesn't work
  - Technically, we

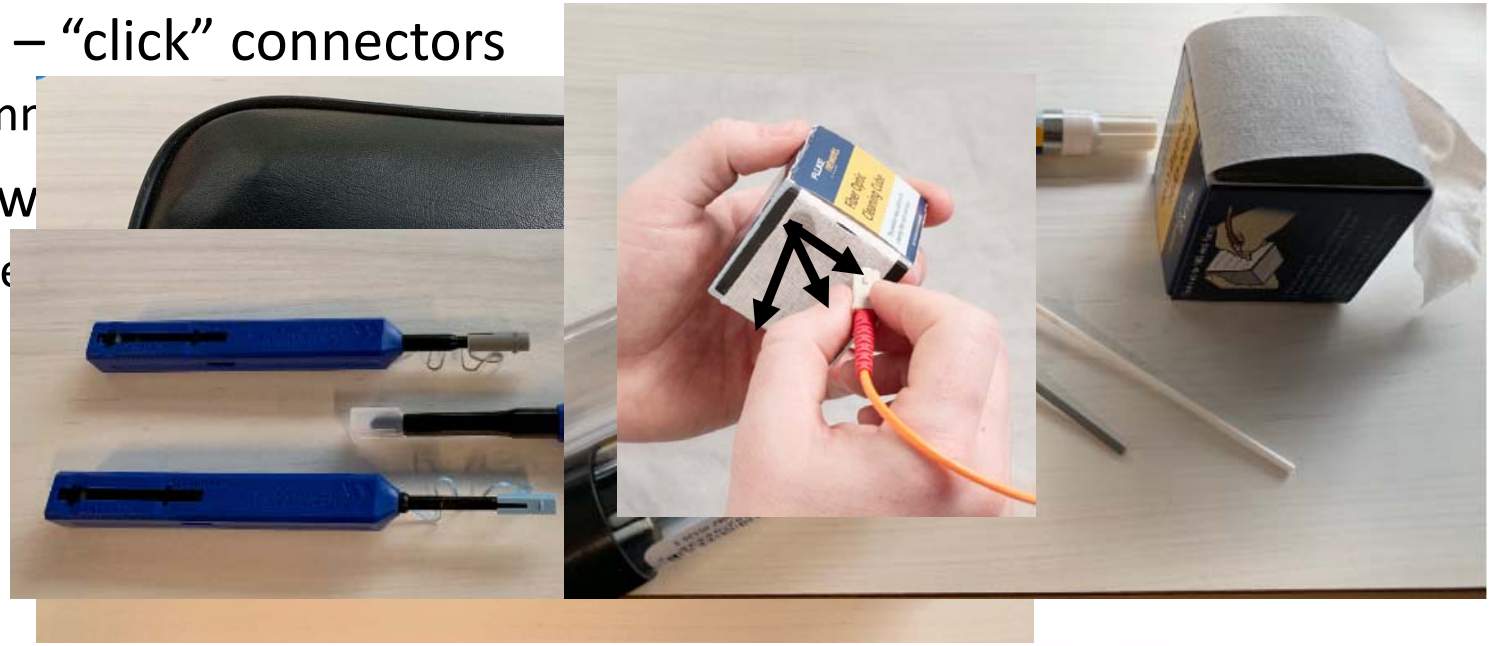

*The cover lifts to insert MPO connectors*



# Contaminants and Reflectance

- Reflectance has been identified as a bigger issue as we move up to higher speed communications
- Changes in the refractive index of different materials, such as the transition from glass to air to glass are a cause of reflectance
- Having another substance with a different refractive index can increase the reflectance caused by mated pairs of connectors
- Fingerprints are like index *un*-matching gel



# *Fingerprints cause more reflectance than loss*

- A study of the impact of a fingerprint on different connector types showed gains in reflectance and limited impact on loss
- Both SM and MM, even 62.5
- Both UPC and APC connectors tested

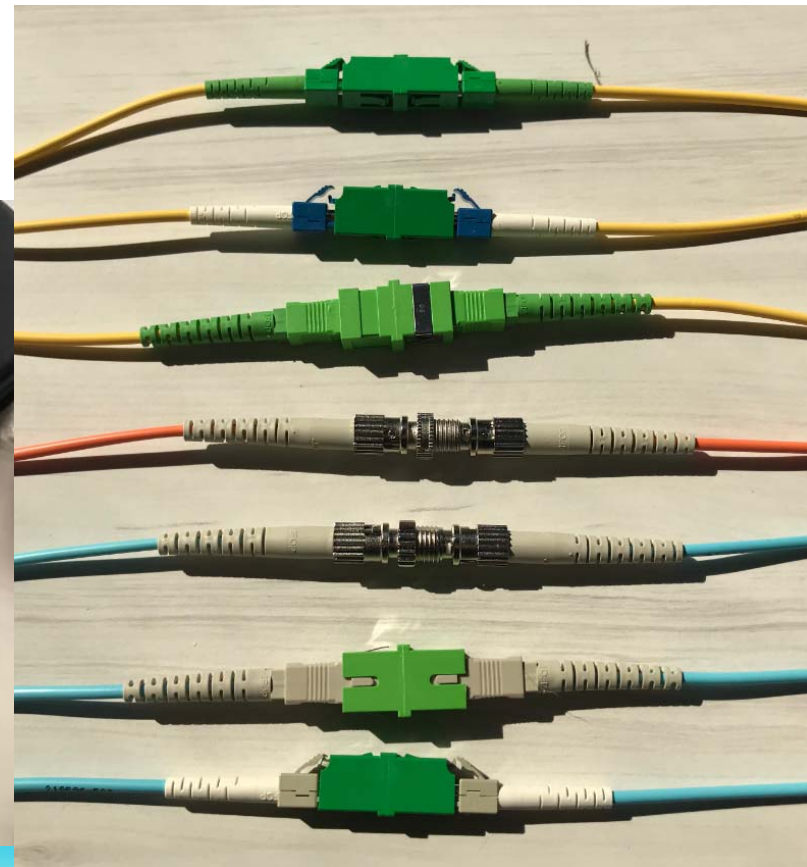



# Pre and Post Fingerprinting – UPC example

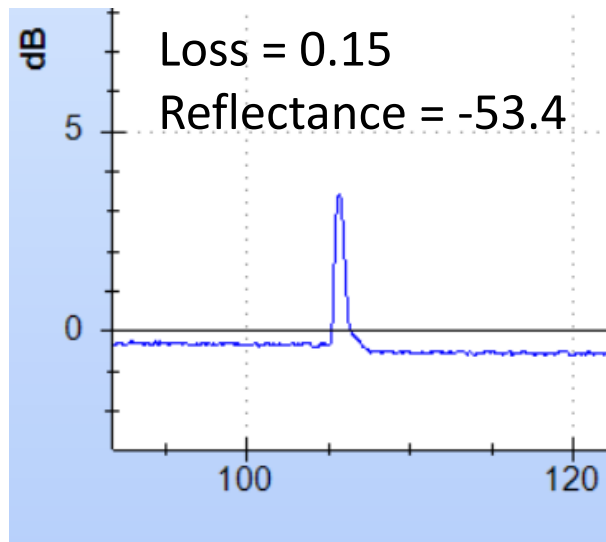

# Pre and Post Fingerprinting – APC example

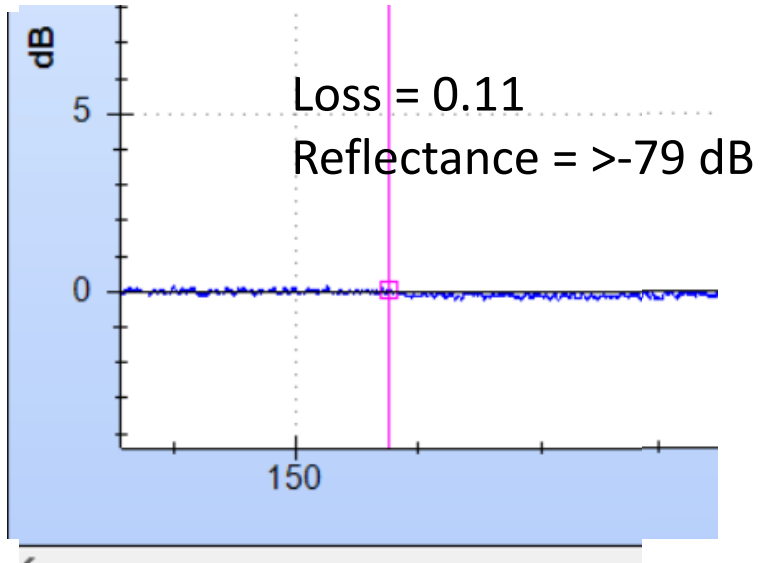

## *In Summary...*

- Inspect all connectors before connecting
- Clean *if necessary* – and inspect again if you do
- Contaminants can:
  - Damage Connectors
  - Increase Loss
  - Increase Reflectance

# Tier 1 (Basic) Fiber Certification

Tyler Vander Ploeg, RCDD

Fiber Solutions Marketing Manager

VIAVI Solutions

# Relevant TIA Standards

- 568.3-D – Optical fiber cabling and component standard
  - Updated to revision “D” in June 2016
  - Transmission performance and test requirements in Clause 7
  - Annex E (informative) provided guidelines for field testing
  - Addendum 1 released in January 2019
- ANSI/TIA-526-14-C-2015
  - Test procedures for installed multimode fiber cable plant
  - Released in April 2015
  - Adaptation of IEC 61280-4-1 Ed. 2.0
  - Encircled Flux for 850nm/50 micron
- ANSI/TIA-526-7-A
  - Test procedure for installed single mode fiber cable plant
  - Released in July 2015
  - Adoption of IEC 61280-4-2 Ed 2.0

# Loss/Length Certification

- Both TIA and ISO/IEC standards specify to tiers of certification
  - Tier 1 (or basic): loss, length, and polarity
  - Tier 2 (or extended): Optical time domain reflectometer (OTDR)
- Tier 2 (extended) tests are an optional addition to tier 1 (basic) tests
- Fiber end-face inspection and certification is also a requirement to ensure pristine end-face condition PRIOR to mating

## Tier 1 (basic) Tests

- Measure Length
- Measure Loss
- Check Polarity
- Ensure Loss does not exceed a “limit” (AKA loss budget)
- Document results

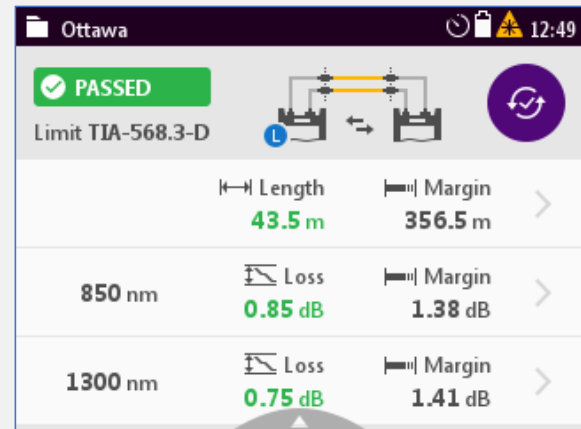

# Leading Causes of Inconsistent Results

1. Not following IEC 61300-3-35

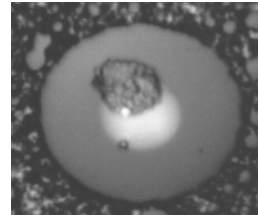

2. Multimode Transmitter Launch Condition

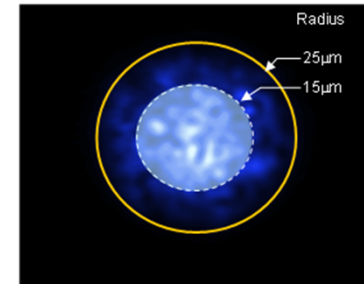

3. Not using Test Reference Cords (TRCs)

4. Errors with Referencing



# Multimode Launch Conditions

- Different multimode light sources = different modal power distributions (commonly referred to as launch conditions)
- Launch conditions directly impact link loss measurements accuracy
  - LED overfills a multimode fiber tending to overstate loss
  - Laser underfills a multimode fiber tending to understate loss

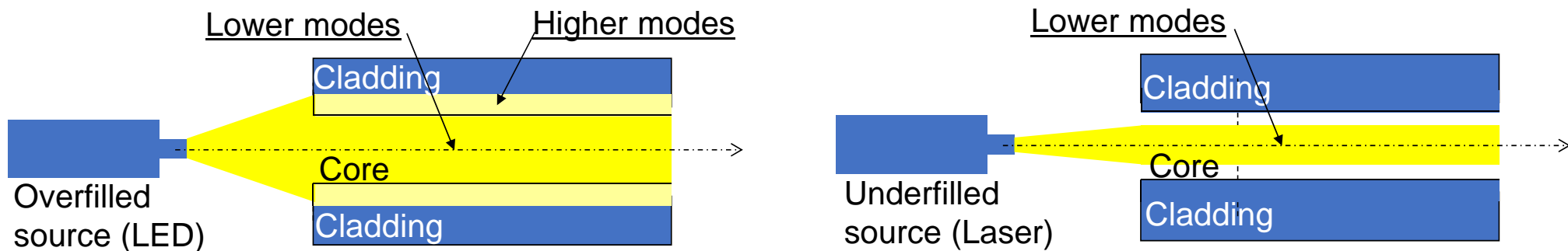



# Test Reference Cords (TRCs)

- Use high performance (reference grade) connectors
  - Optimal optical and geometrical characteristics
    - Numerical aperture (NA)
    - Core/ferrule concentricity
- When mated with other TRCs produce near zero loss
- Minimizes uncertainty
- Called for in various standards for loss measurements of installed fiber cabling

The connector or adapter terminating the launch cord shall be compatible with the cabling and the termination should be of reference grade to minimize the uncertainty of measurement results.

Source: IEC 61280-4-2

# Losses associated with mating of TRCs

**Table G.1 – Expected loss for examples** (see NOTE 1)

Termination 1	Termination 2	Attenuation requirement
SM reference grade	SM reference grade	≤0,2 dB
SM reference grade	SM standard grade	≤0,5 dB
SM standard grade	SM standard grade	≤0,75 dB

NOTE 1 Table G.1 shows the required performance of standard and reference grade SC connectors in accordance with IEC 60874-14-2. These values are found in other, but not all, performance standards for connecting hardware.

NOTE 2 Current studies by JWG8 of IEC SC86A and SC86B on reference grade terminations may produce values for other connector styles.

Source: IEC 61280-4-2

**Table F.1 – Expected loss for examples (Note 1)**

Termination 1	Termination 2	Attenuation requirement
MM Reference grade	MM reference grade	≤ 0,1 dB
MM Reference grade	MM standard grade	≤ 0,3 dB
MM standard grade	MM standard grade	≤ 0,5 dB (note 2)

NOTE 1 Table F.1 shows the required performance of standard and reference grade terminations in accordance with IEC 60874-19-1. These values are found in other, but not all, performance standards for connecting hardware.

NOTE 2 97 % of individual connections are required meet this attenuation limit. As a minimum of two connections are present within installed cabling, a value of 0,5dB is quoted on a statistical basis.

Source: IEC 61280-4-1

# Correct Steps for Referencing

- Turn units on and let sources warm up for 10-20 min
- Select and configure appropriate limit
- Set reference method on device
- Connect devices together according to reference method selected (IBYC)
- Perform reference
- Verify reference (IBYC)
- Test (IBYC)

# Setting a 1 Cord Reference:

- Connect the OLTS together w/TRC – reference power meter (set to 0dB)



- Disconnect the fiber at the power meter. Connect a TRC to the power meter. Connect to the fiber system under test

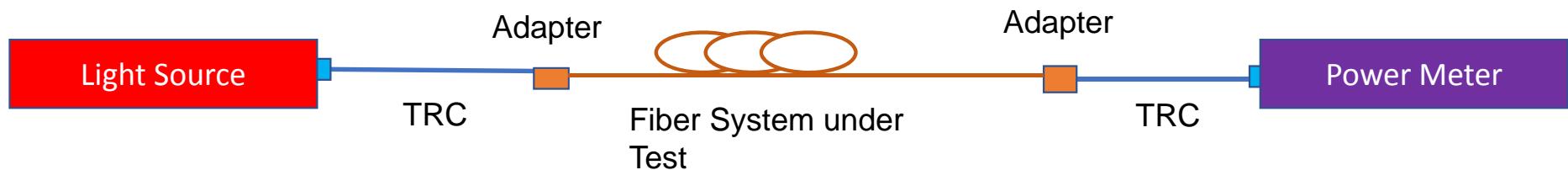

OLTS = Optical Loss Test Set. Typically has Light Source and Power Meter at both ends. Simplex shown for clarity.

# Reference Verification

- Connect test cords together and measure loss

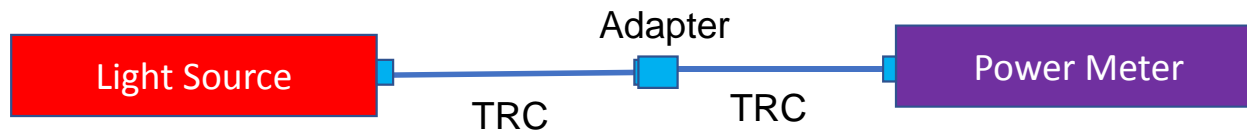

- Ensure no “gainers”
  - Negative loss on most loss test sets
- Ensure loss does not exceed the values for TRC-TRC connections
  - Multimode  $\leq 0.1$  dB
  - Single mode  $\leq 0.2$  dB
- Save result for proof of good reference

# Loss Limits

- Acceptable loss limit is based on several factors:
  - Number of connections
  - Number of splices
  - Loss per Km (at specific wavelengths)
- Maximum **allowable** losses
  - Loss per connection = 0.75 dB
  - Loss per splice = 0.3dB
  - Loss per Km (slope)
    - 850nm = 3.0 dB
    - 1300nm = 1.5 dB
    - 1310 nm = 1.0 dB
    - 1550 nm = 1.0 dB

No of Connections	0 ▶
Loss Per Connection (dB)	0.75 ▶
No Of Splices	0 ▶
Loss Per Splice (dB)	0.30 ▶
Cable Loss (850nm)	3.5 dB/Km
Cable Loss (1300nm)	1.5 dB/Km

For Tier 1 Certification the user must tell the OLTS how many connections and splices are in the fiber system under test

# Loss Limit Example

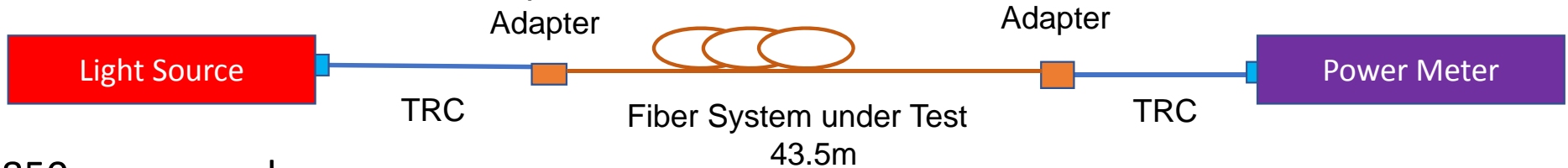

- 850 nm example:
  - Cabled fiber attenuation allowance = 3.0dB/km (0.13dB)
  - Test cord attenuation allowance = 0.3dB x 2 (0.6dB)
  - If no connections or splices in system under test, loss budget = 0.73dB
  - If two connections (0.75dB/connection) in system under test, loss budget = 2.23dB

Limit is based on settings  
Loss is measured  
Margin is calculated

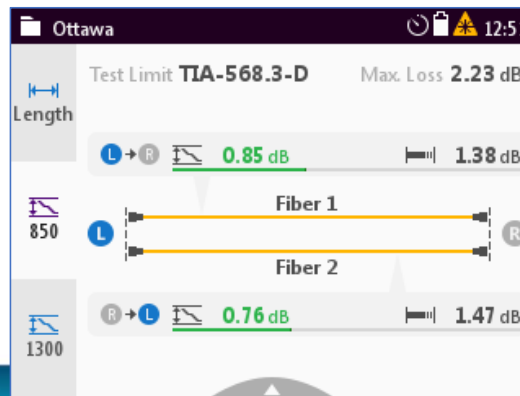

Element	Limit
Cable Attenuation	0.13dB
Test Cord Attenuation (2)	0.6dB
Splices (0)	0
Connections (2)	1.5dB
<b>TOTAL</b>	<b>2.23dB</b>

# Will My Application Actually Work?

- In this context, application is the protocol that will “ride” on the fiber.
  - Typically Ethernet or Fiber Channel
- What is the connection between the “limit” on the previous slide and what the application requires?
  - Very little...

Cable Type	1GbE		10GbE		40 /100GbE	
	Loss (dB)	Length (m)	Loss (dB)	Length (m)	Loss (dB)	Length (m)
OM3	4.5	1000	2.6	300	1.9	100
OM4	4.8	1100	3.1	1100	1.5	150

Loss and Length Limits at 850nm



# Compliant Networks

- Most Enterprise Optical Loss Test Sets will report “Compliant Networks” based on loss measurement
- Cautions! –
  - Can “PASS” standards-based generic limit, but have too much loss for specific application
  - Most testing performed is on links – but applications run on channels
- If the Application to be carried on the fiber is known, use Application (Network) limit

— Compliant Networks —



1000BASE-LX_MM	1000BASE-SX	100GBASE-ER4
100GBASE-LR4	100GBASE-SR4_OM3	100GBASE-SR4_OM4
10BASE-FB	10BASE-FL	10GBASE-LR/LW
10GBASE-LX4	10GBASE-SR/SW	40GBASE-SR4_OM3
40GBASE-SR4_OM4	1Gbps-FC_OM2_MM	1Gbps-FC_OM3_MM
2Gbps-FC_MM	2Gbps-FC_OM2_MM	2Gbps-FC_OM3_MM
4Gbps-FC_OM1_MM	4Gbps-FC_OM2_MM	4Gbps-FC_OM3_MM
8Gbps-FC_OM1_MM	8Gbps-FC_OM2_MM	8Gbps-FC_OM3_MM
ISO-14165-111_MM		

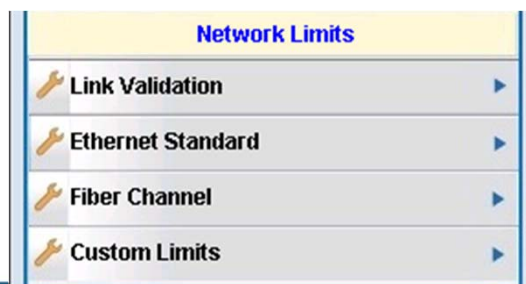

# Summary

## Ensure Your Results Are Accurate and Consistent

- Treat your test reference cords AND the fiber under test with respect
  - Inspect and clean ALL fibers ALL the time
    - Inspect Before You Connect<sup>SM</sup>
    - IEC 61300-3-35 Certification
- Understand your multimode launch condition and have a plan to move to Encircled Flux
  - Standard modal power distribution = consistent loss results between testers
- Understand reference methods and their impact on limit, loss, and margin
  - Reference method chosen in tester setup is correct and matches actual physical setup
  - Verify and check the reference often
  - Use test reference cords
- Complement your loss/length certification with OTDR

# Tier II Testing - OTDR

Rob Gilberti

Business Development Manager

AFL

# The OTDR Trace

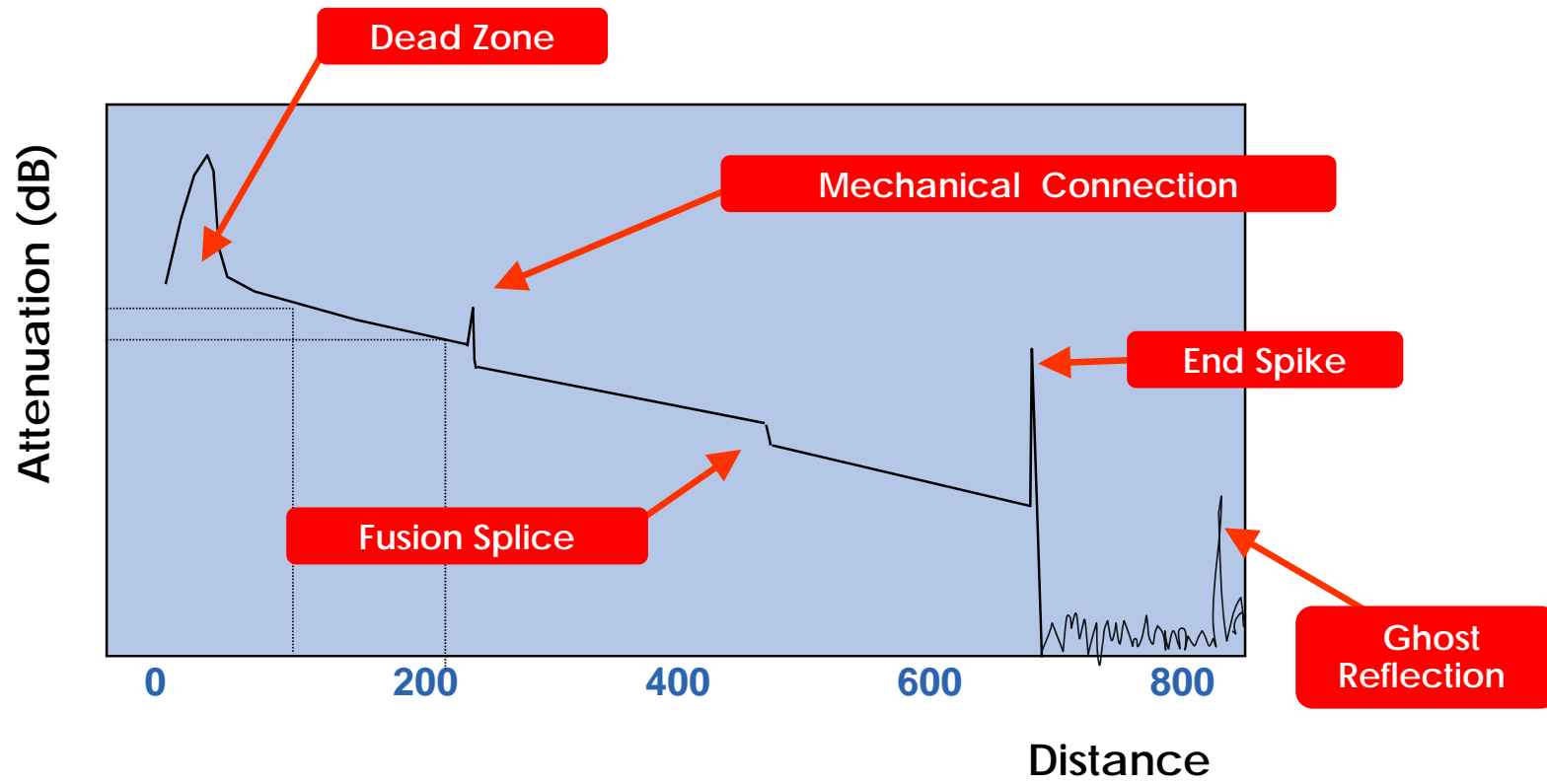

# OTDR Two-point insertion loss including end connections

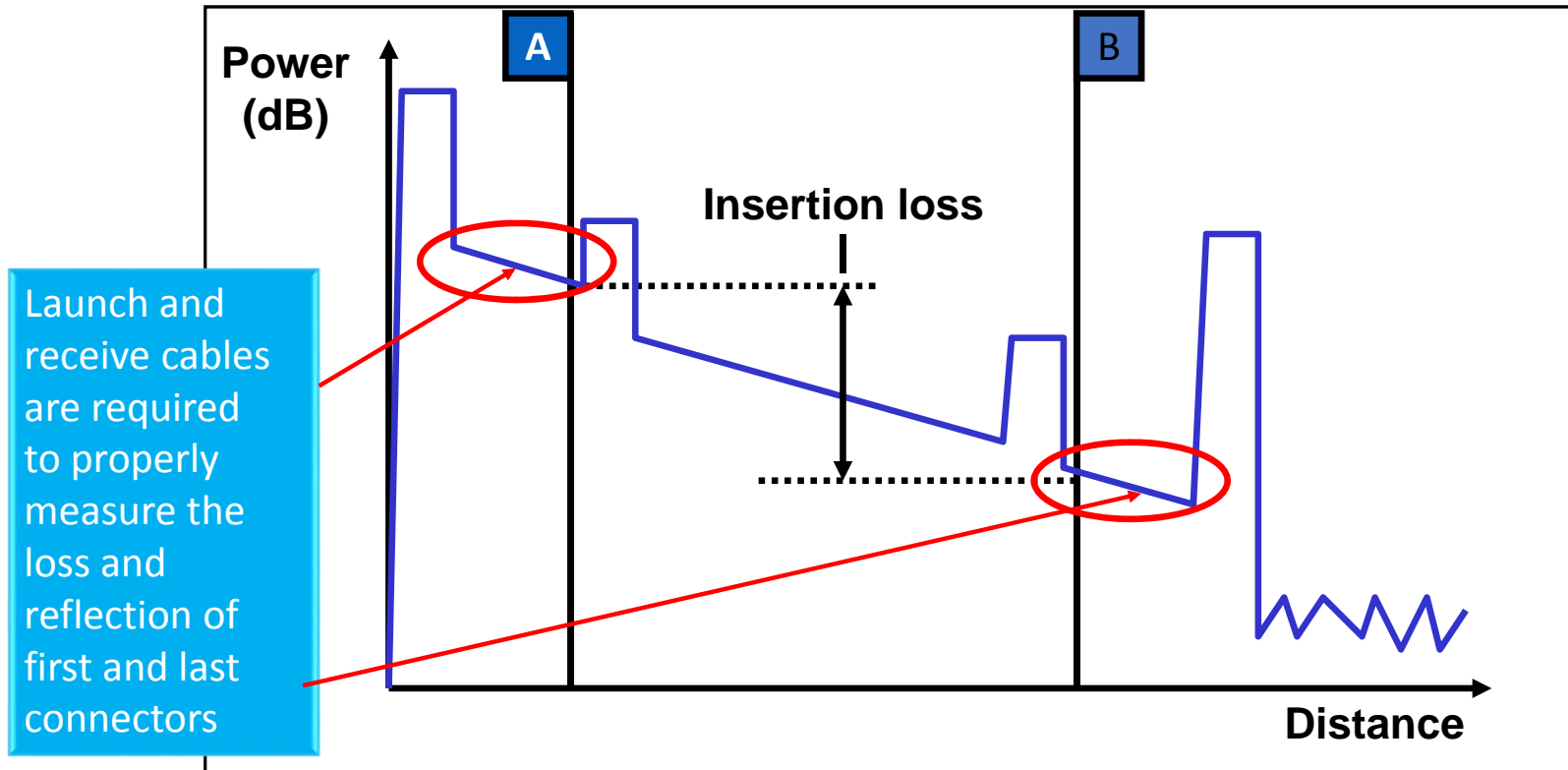

# Using an OTDR to Fault Locate

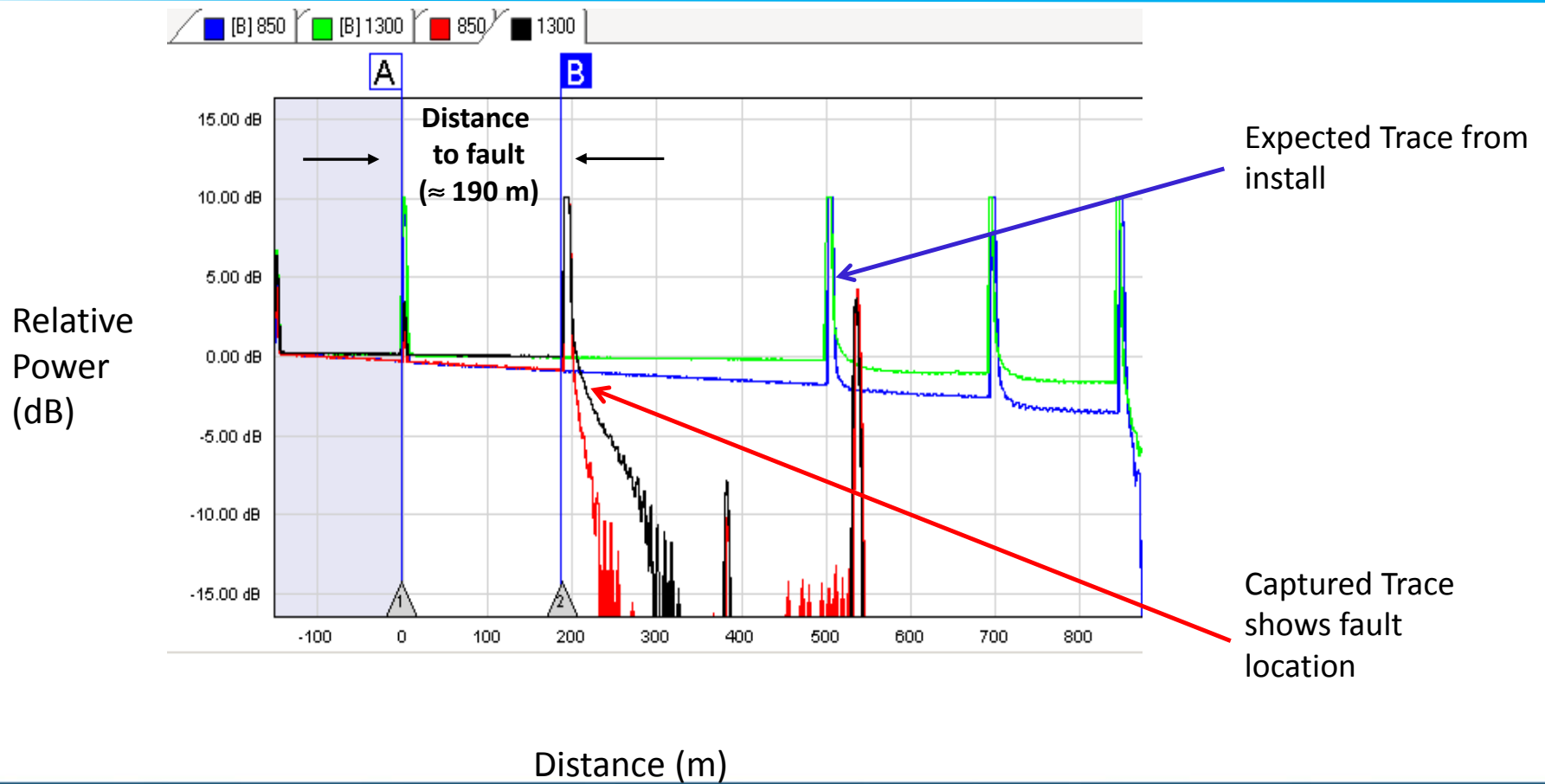

# OTDR Bi-Directional Testing

- If backscatter characteristics are different from each fiber, measured loss across the event will be exaggerated in one direction and reduced in the other direction
  - Different fiber types (e.g. G.652.D vs. G.657.B2) have different backscatter
  - Older fiber typically has higher backscatter than newer fiber
- A more accurate measure of an event's loss is obtained by testing the network from each end and averaging the measured event loss in both directions at each event

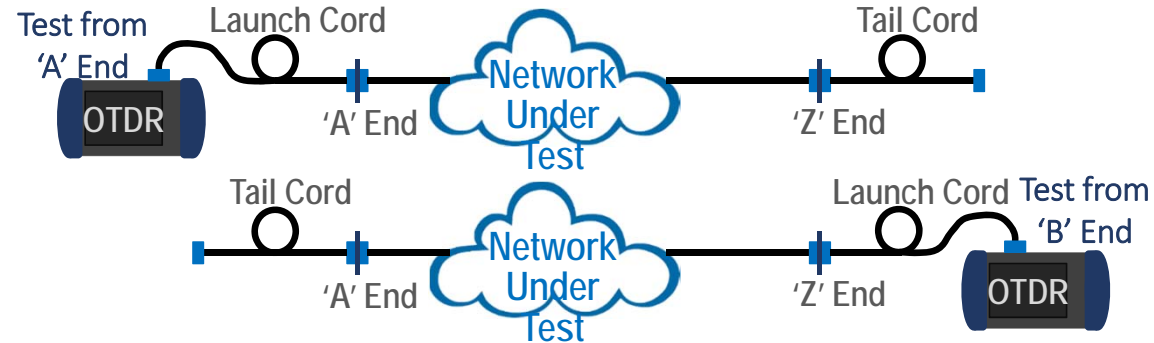

# Reflectance – It's important!

## Standards

	<u>10Gbase</u>	<u>TIA-568.3-D</u>	<u>Industry</u>
SMF	-26dB	-35dB	-35 to -50dB (UPC)
MMF	-20dB	-20dB	

High Reflectance can indicate poor quality connections or UPC/APC mismatches

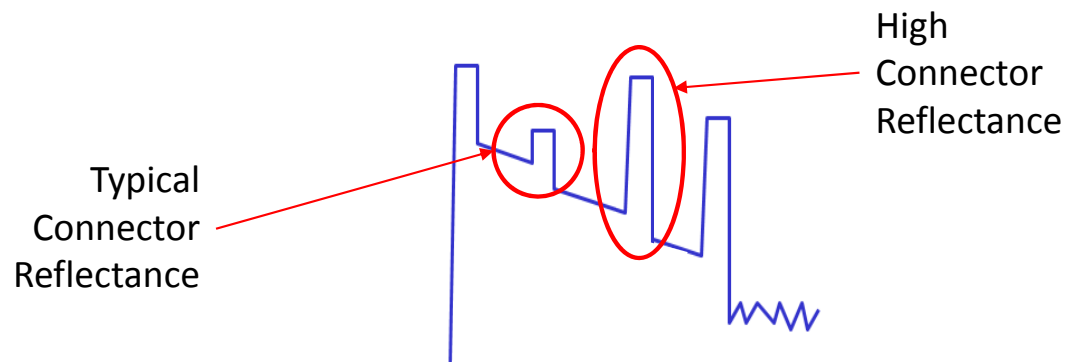



# Enterprise/Smart Bldgs. - PON/POLAN OTDR Testing

## Forget Testing from OLT end using OTDR... Here's why:

- 1) Normal trace from OLT to Splitter
- 2) Backscatter & reflections from fibers overlap beyond splitter
  - Fault in one fiber hidden by backscatter & reflections from overlapping drop fibers
  - Even if fault detected, no way to determine which splitter leg has problem
- 3) Splitter appears as high-loss event -- Could be declared as fiber end

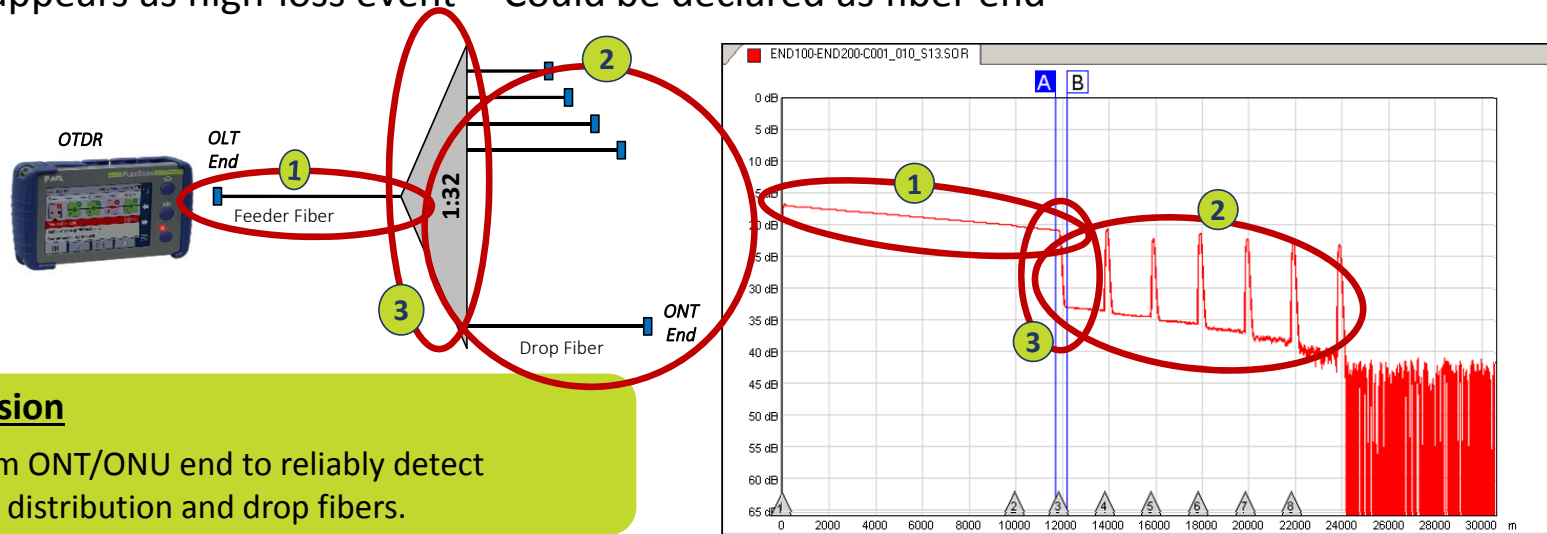

### Conclusion

Test from ONT/ONU end to reliably detect faults in distribution and drop fibers.

# Testing Passive Optical LAN

Romain Tursi  
Product Specialist  
EXFO

# Introducing POL

- POL is the evolution of FTTH into LAN
- Active equipments at both ends
  - 1 Optical Line Terminal (OLT) communicating with...
  - ... multiple Optical Network Terminals (ONTs) on user side
- Completely passive Optical Distribution Network (ODN) in between
  - Singlemode fiber,
  - No power consumption
- Splitter(s)
  - Small size, replaces equipment racks at floor level
  - Divide the downstream signal power into multiple legs / Aggregate upstream signal power toward OLT
  - Split ratio will determine how many ONTs/users served

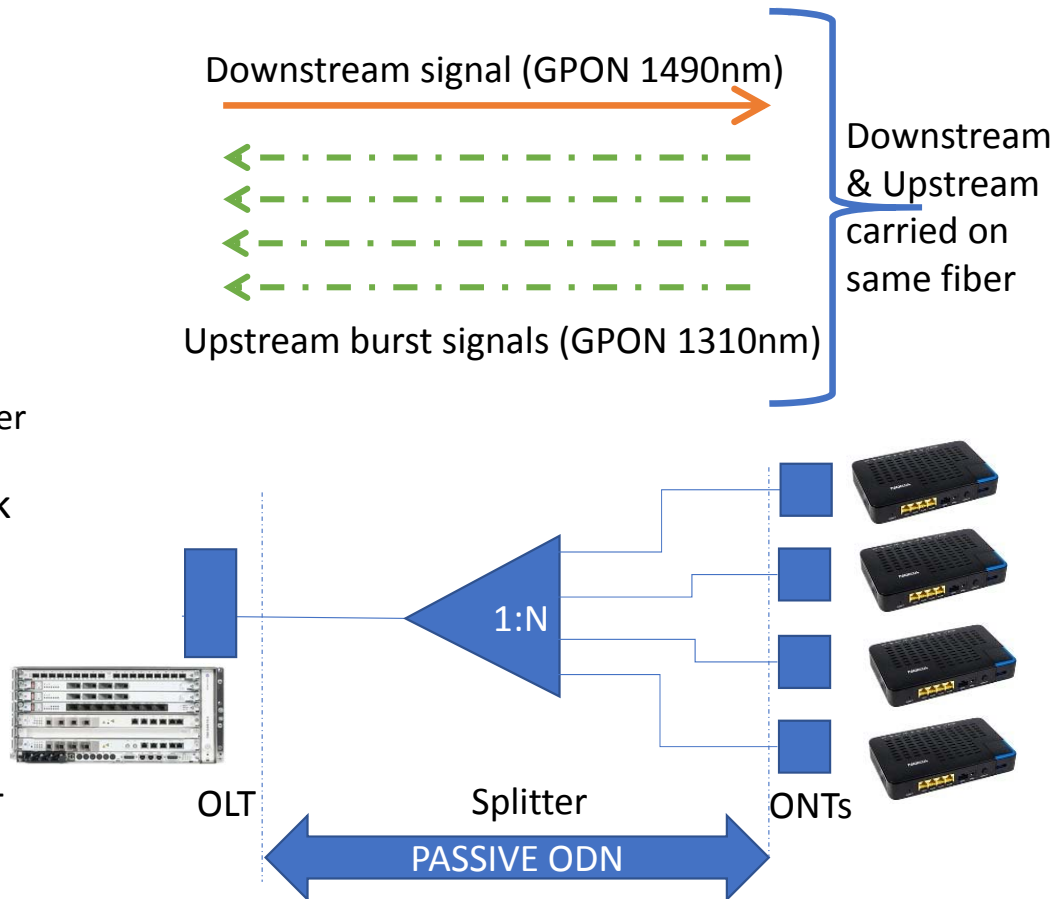

# Testing POL

- Testing tools & MOPs were developed for FTTH/GPON since 2002, now used for POL
  - Hundreds of NSPs have successfully deployed their networks using automated & intelligent test tools
- ⇒ Use the expertise gained over the years in FTTH and avoid pitfalls
- ⇒ Deploy quality networks, on time and within budget thanks to testing tools and MOPs adapted to PON/POL

Specific to  
PON/POL

# Key testing considerations

	Connector endface cleanliness	Fiber-link characterization	PON signals validation	Network documentation	Network Live troubleshooting
<u>What you should do:</u>	perform visual inspection to detect dirty/damaged connectors; clean them if required	look for anything potentially impacting total budget loss (dB), such as macrobends, splices, bad connectors, unbalanced loss at splitter, fiber breaks, etc.	During service action, check for power level assessment of active components to validate signal levels for all services	properly identify all fibers, test results and test reports	Find faulty elements preventing the system to work for one or multiple users
<u>The tool you need:</u>	fiber inspection probe	OLTS PON OTDR capable to measure splitter	pass-through PON power meter	post processing software	OTDR with a filtered fiber port

# Construction, Testing through splitter(s) (1/2)

## OLTS Testing

- Unit at OLT side remains connected, Unit at ONT side move to each leg ends of the given splitter
- No duplex (pair) testing, simplex only (1 path at a time)

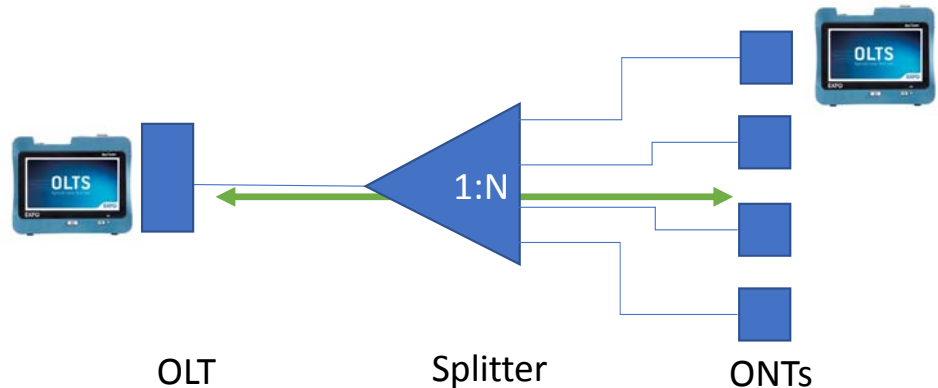

# Construction, Testing through splitter(s) (2/2)

## OTDR Testing

- From the ONT up to the OLT
- PON Optimized that can quickly recover after splitter high loss to characterize the splitter and keep visibility on section between splitter and OLT
- Multiple pulses for optimal resolution on each section

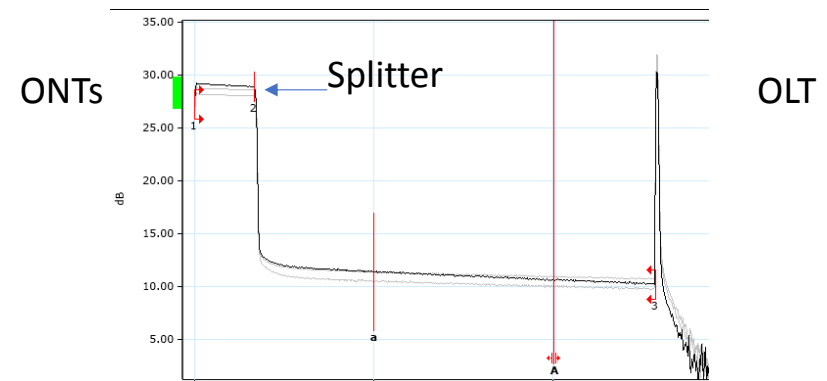
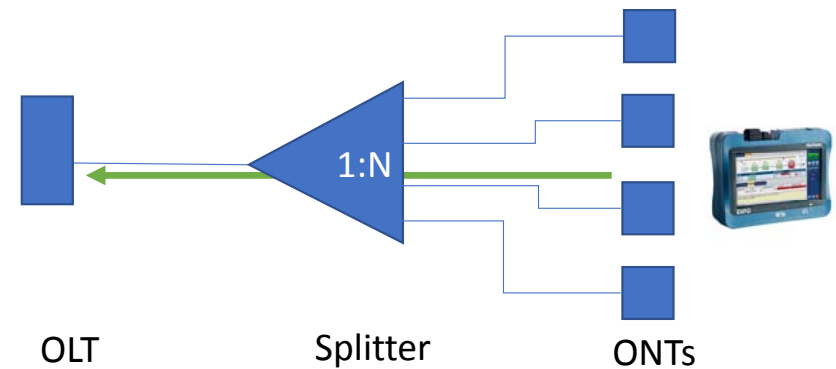

# Service activation - PON power meter

- ONT – no transmit until it's receiving OLT signal:
  - Need a **power meter with pass-through connection**
- Downstream and upstream signal are present at same time:
  - Need **filtered detectors**, permitting individual measurement of each wavelengths
- ONTs communicates one after the other, not in continuous
  - Traditional power meter will do a continuous averaging of the incoming power displaying much lower power than actual, you need a power meter permitting to **measure bursts for upstream validation**

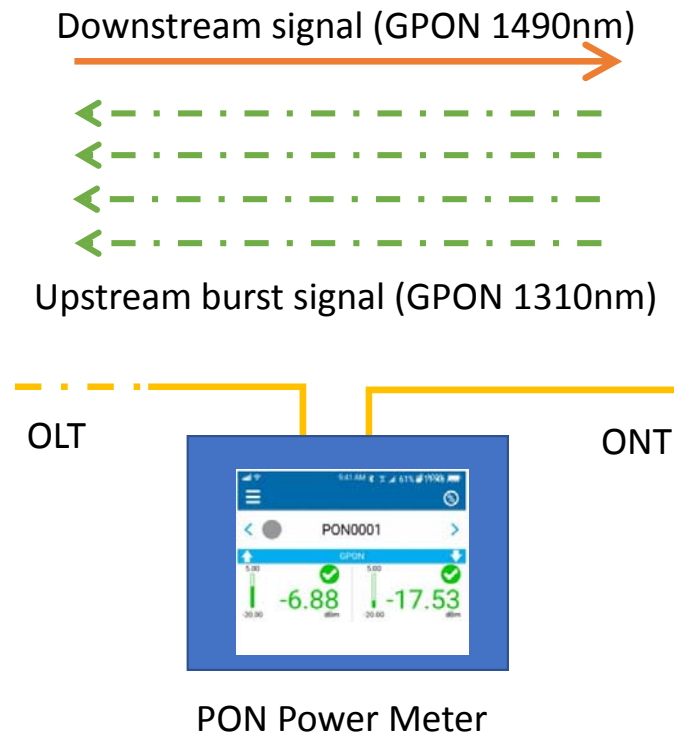



# Live POL network Troubleshooting

- Troubleshooting on active networks with live fiber (1490nm downstream in GPON)
- Need filtered port to block incoming signal
- OTDR SM live port using 1625 or 1650nm (out-of-band)
- No interference with other active users in the network
- Accurate fault location using multipulse OTDR technology

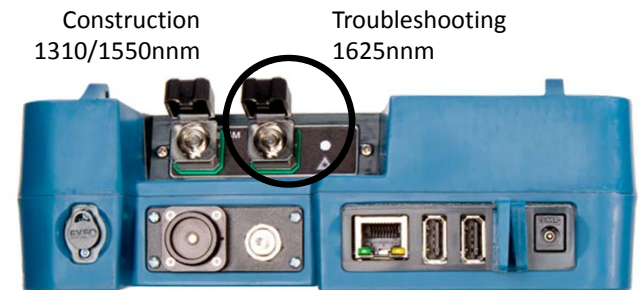
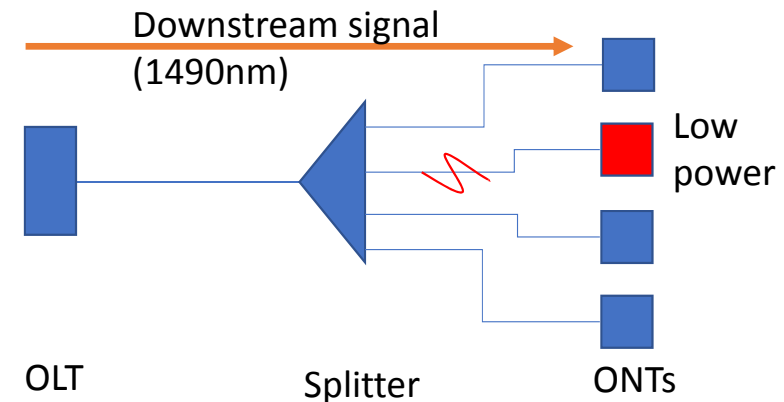

# Back-up Slides

# How to determine which OTDR Pulse Width to use

## Too Narrow

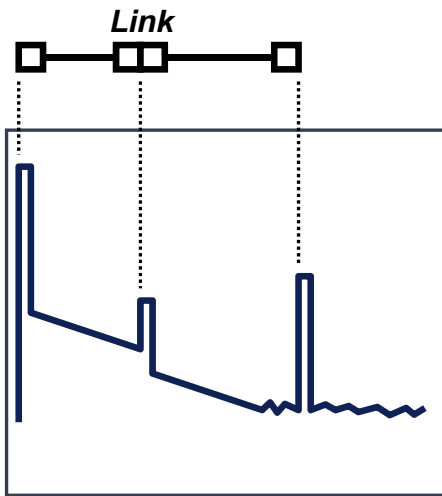

Trace “disappears”  
into noise floor

## Too Wide

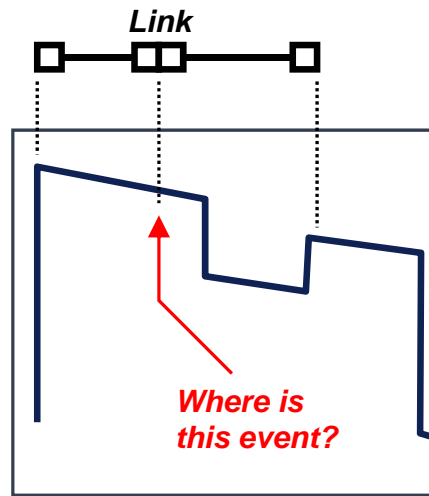

Can't resolve events

## About Right

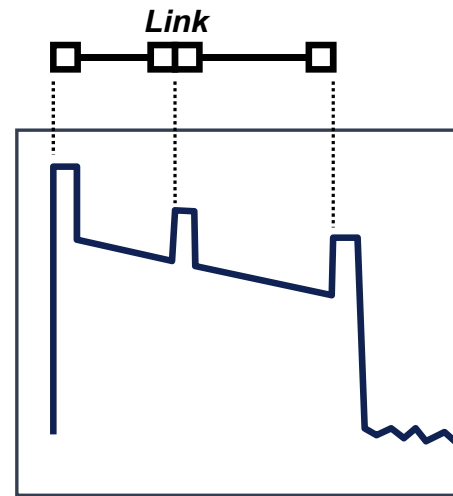

Events can be seen  
and trace is smooth

*Multi-Pulse  
Acquisition*

*Combines results of  
multiple pulsewidths*

# Multi-fiber OTDR Testing with MPO Switch

---



Connect to MPO Network or use Hydra/Breakout to connect to individual fibers/connectors

OTDR controls switch via USB and Software cycles through 12 fibers automatically testing each fiber

OTDR captures .SOR files for 12 individual fibers for dual wavelength and consolidates data for single report

# Testing Live Fiber with PON/POLAN Networks

- OTDR test at 1310, 1490, 1550 nm disrupts service to other customers
- Downstream 1490 nm (or 1550 nm) signals interfere with OTDR's receiver
- Use **Live PON OTDR** to test in-service PON:
  - OTDR laser at **out-of-band wavelength** (e.g. 1625 or 1650 nm)
  - PON OTDR Includes **filtered detector** to reject in-service wavelengths (e.g. 1490, 1550)
  - PON OTDR may include integrated **PON Power Meter** to check downstream levels





## Backup Slides

# Channels and Links – Applies to Fiber as Well

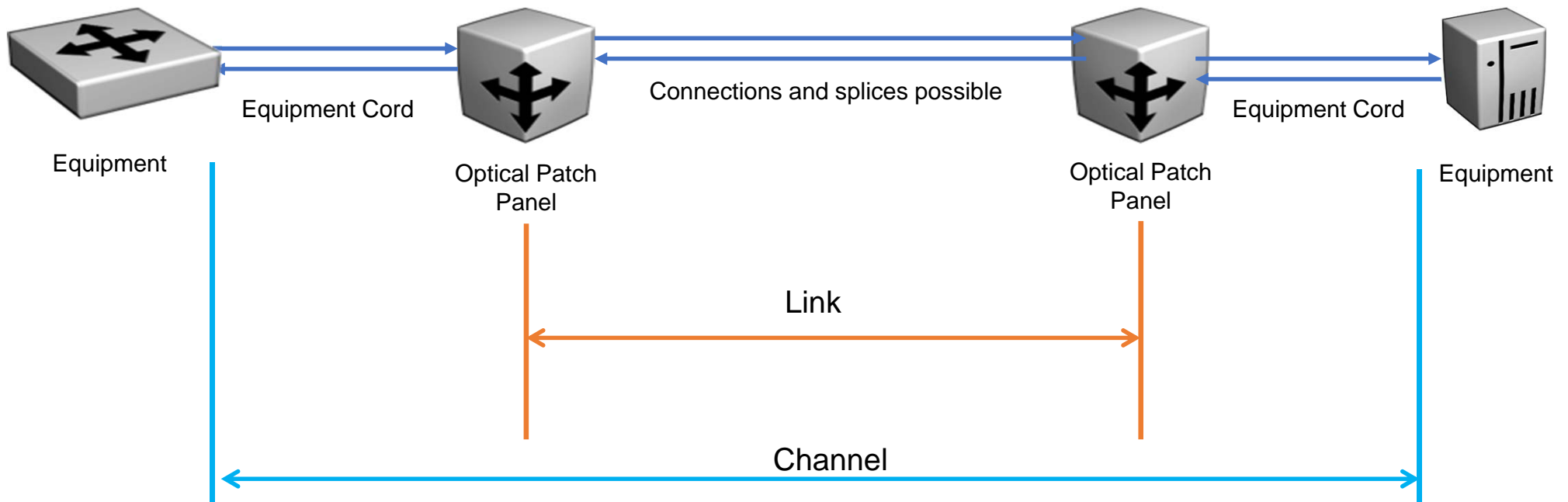

# End-Face Condition

## **Annex B** (normative)

### **Visual inspection criteria for connectors**

The visual inspection criteria for connectors shall be performed in accordance with IEC 61300-3-35.

Source: ISO/IEC 14763-3

A microscope compatible with IEC 61300-3-35, low resolution method, is required to verify that the fibre and connector end faces of the test cords are clean and free of damage. Microscopes with adaptors that are compatible with the connectors used are required.

Source: IEC 61280-4-1

A microscope compatible with IEC 61300-3-35, low resolution method, is required to verify that the fibre and connector end faces of the test cords are clean and free of damage. Microscopes with adaptors that are compatible with the connectors used are required.

Source: IEC 61280-4-2



# Inspect and Clean Both Connectors in Pairs!

**Inspecting BOTH sides** of the connection is the **ONLY WAY** to ensure that it will be free of contamination and defects.



**Patch Cord** (“Male”) Inspection



**Bulkhead** (“Female”) Inspection

Patch cords are easy to access and view compared to the fiber inside the bulkhead, which is frequently overlooked. The bulkhead side may only be half of the connection, but it is far more likely to be dirty and problematic.

# Cleaning Best Practices

- Many tools exist to clean fiber
- Many companies have their own “best practices”
- Dry clean first. If that does not clean, then try wet cleaning.
- Always finish with dry cleaning.



# IEC 61280-4-1 sets standards for MM launch conditions

- Ratio between the transmitted power at a given radius of the fiber core and the total injected power
- Defined in IEC 61280-4-1 standard to characterize the launch conditions of MM test sources
- Is measured at the launch cord connector – NOT at the source output
- Replaces older “launch condition” requires such as Coupled Power Ratio (CPR)
- Can be achieved by using a universal or matched modal controller

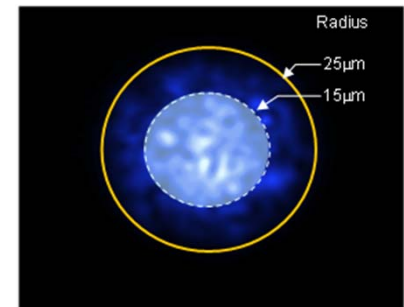
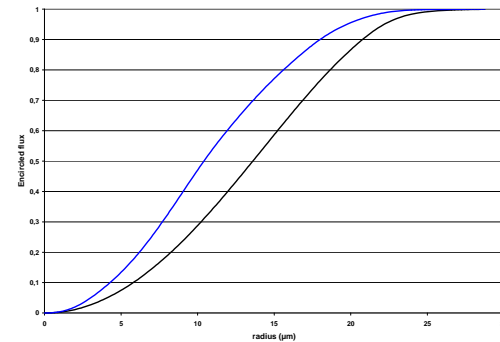

# MM Launch Condition

## **Launch modal conditions for testing multimode optical fibre cabling**

The launch modal condition at the point of measurement, at the output of launch cords, shall meet the requirements of IEC 62614 and IEC 61280-4-1. The launch modal condition at the point of measurement, the light emitted by the core of the reference connector may be achieved in several ways.

Source: IEC 14763-3

# Universal and Matched Controllers

- Universal Controller

- For legacy sources
- Adds a “black box” to the output of the legacy source

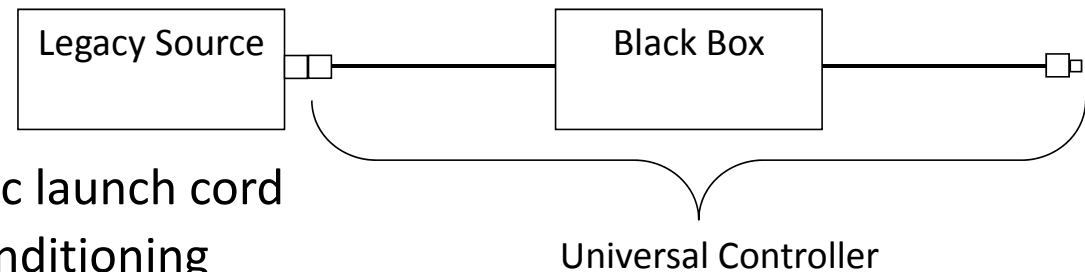

- Matched Controller

- Specific source matched with specific launch cord
- Launch cord may have additional conditioning

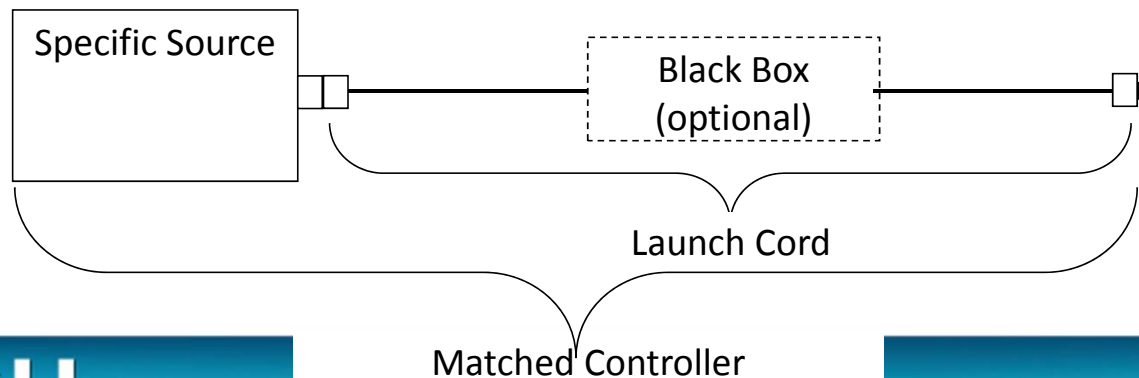

# One-Cord Reference Method

The one-cord reference method measurement includes the attenuation of both connections to the cabling under test. It is the RTM for measurement of installed cabling plant of configuration A (see 4.2).

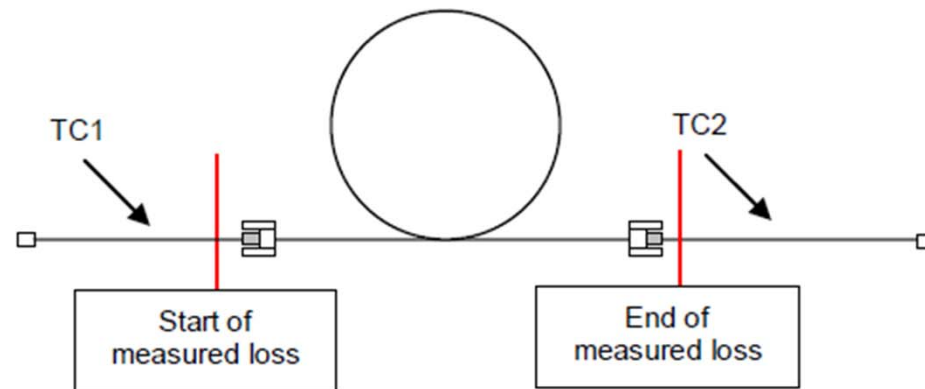

**Figure 3 – Configuration A – Start and end of measured losses in reference test method**

NOTE 1 Figure 3 is an example of cabling in configuration A with test cords TC1 and TC 2 attached, illustrating the start and end point of the measured losses when the reference test method is used (the one-cord reference method as detailed in Annex A).

Source: IEC 61280-4-2

## Setting 2 Cord Reference:

- Connect the OLTS together using two TRCs and an adapter – reference power meter (set to 0dB)



- Disconnect the fibers at the **adapter** and connect the system to be tested.

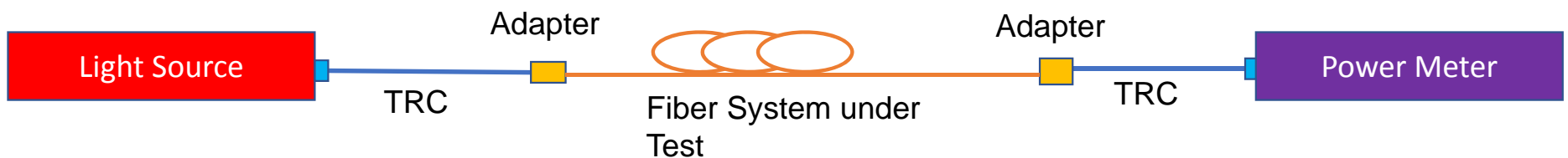

## Setting 3 Cord Reference:

- Connect the OLTS together with two TRCs, two adapters AND a third TRC – reference power meter (set to 0dB)



- Disconnect the fibers at the **adapters**, remove the third TRC and connect to the system to be tested.





# Summary of Reference Methods

- Difference is the number of bulkhead (adapter) connections included in the loss measurement.
- Use the method recommended by your local standards OR by your vendor!
- For link testing, 1 cord method is universally recommended

Losses included in measurement based on reference method

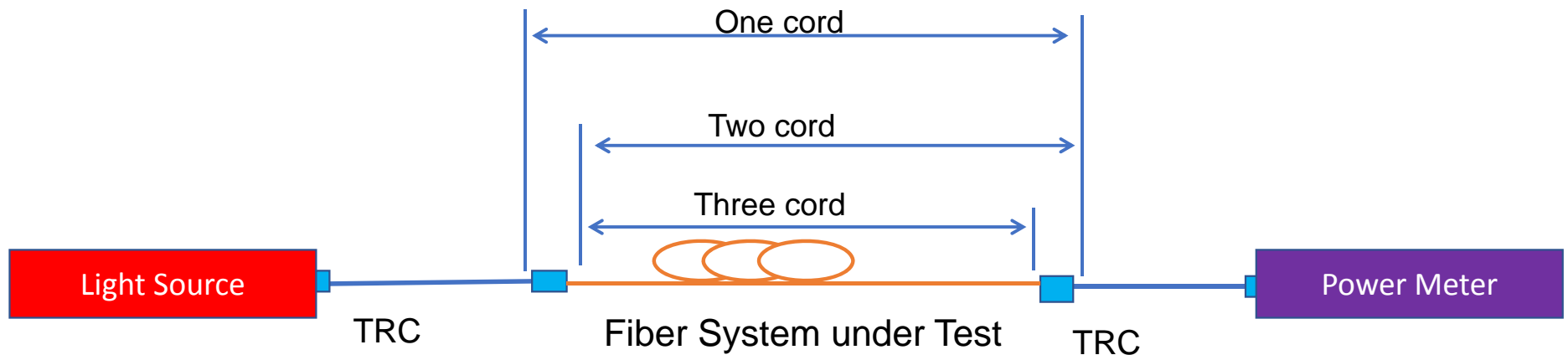

# Calculating Standards-Based Limits

**Link Attenuation Allowance (dB) = Cabled Fiber Attenuation Allowance (dB) + Connections Attenuation Allowance (dB) + Fiber Splices Attenuation Allowance (dB) + Test Cord Attenuation Allowance (dB)**

Where:

- *Cabled Fiber Attenuation Allowance (dB) = Maximum Cabled Fiber Attenuation Coefficient (dB/km) × Length (km)*
- *Connections Attenuation Allowance (dB) = Number of Connections within the link × Connection Loss Allowance (dB/connection)*

Note: The number of connections within the link excludes the connections on the ends of the link to the test cords that are accounted for subsequently as Test Cord Attenuation Allowance.

- *Fiber Splices Attenuation Allowance (dB) = Number of Splices × Fiber Splice Loss Allowance (dB/splice)*
- *Test Cord Attenuation Allowance for one-cord reference method = 2 × Test Cord Loss Allowance*
- *Test Cord Attenuation Allowance for two-cord reference method = 1 × Test Cord Loss Allowance*
- *Test Cord Attenuation Allowance for three-cord reference method = 0 × Test Cord Loss Allowance*